

EXS210054-01

EXS1550-060-10-0201130

SLED Butterfly 1550nm

Revision: 1.0

Date: 20-03-2012

Confidentiality: **None**

Prepared by: Raffaele Rezzonico
(Product Support Technician)

Checked by: Chris Armistead
(Engineering Manager)

Approved by: Philippe Crépellière
(Quality Manager)

Authorized by: Marcus Duellk
(CTO)

CONTENTS

1. SCOPE.....	3
1.1 PURPOSE.....	3
1.2 RESPONSIBILITY	3
2. REFERENCE DOCUMENT.....	3
3. ELECTRO-OPTICAL PERFORMANCE ($T_{SLED} = 20^{\circ}C$)	3
4. ABSOLUTE MAXIMUM RATINGS	4
5. SCREENING	4
6. PACKAGE DIMENSIONS [MM]	5
7. FIBRE AND CONNECTOR.....	5
8. IMPORTANT NOTES.....	6
9. ORDERING INFORMATION.....	6
9.1 TECHNICAL DESCRIPTION.....	6
10. REVISION HISTORY	7

1. SCOPE

1.1 PURPOSE

The purpose of this document is to specify the electro-optical performance and dimensions of superluminescent light emitting diode (SLED).

1.2 RESPONSIBILITY

EXALOS is responsible for establishing, implementing and maintaining this procedure. The Quality representative shall ensure that a timely Engineering Change Notice (ECN) is issued in accordance with EXALOS procedure for any changes.

2. REFERENCE DOCUMENT

- EXS-WI-0001 Visual Inspection Criteria SLED Chip on Submount Procedure
- MIL STD 883 C method.
- Bellcore GR-468-CORE.

3. ELECTRO-OPTICAL PERFORMANCE ($T_{SLED} = 20^{\circ}C$)

Parameter	Symbol	Cond.	Min	Typ	Max	Unit
Operating Current	I_{op}				250	mA
Power in SMF	P_o	$I_{op, max}$	6	10		mW
Center Wavelength	λ_c	$I_{op, max}$	1525	1545	1565	nm
Bandwidth FWHM		$I_{op, max}$	50	60		nm
Spectral ripple [RB=0.1nm]		$I_{op, max}$		0.1	0.3	dB
Monitor PD Current*	I_{MPD}	$I_{op, max}$	0.1			mA
Monitor PD bias voltage			0		-12	V

* Measurement conditions:

- $I_{op} = I_{op} \text{ Max}$
- Monitor PD bias voltage: 0 Volts

Input resistance of the Monitor PD current measurement circuit 10 Ohm

4. ABSOLUTE MAXIMUM RATINGS

Stresses beyond the absolute maximum ratings may cause permanent damage to the device. Exposure to absolute maximum rating conditions for extended periods may affect device reliability.

Parameter	Symbol	Cond.	Min	Max	Unit
Forward current	I_F			350	mA
Reverse voltage	V_R			-2	V
Forward voltage	V_F	$I_{F,max}$		2	V
Storage temperature	T_{stg}		-40	85	°C
Operating temperature	T_{op}	$I_{F,max}$	-20	65	°C
Storage humidity	$<30^{\circ}C$ $>30^{\circ}C$		5	95	% r.h.
				85	% r.h.
Thermoelectric cooler voltage	V_{tec}	**		4.0	V
Thermoelectric cooler current	I_{tec}	**		1.8	A
Thermistor Resistance	R_{th}	$20^{\circ}C$	12.5		K Ω
Thermistor constant	B		3892		K
Lead soldering temperature				260	°C
Lead soldering duration				10	s
ESD		human b.m		500	V

** Performance values with hot side temperatures $50^{\circ}C$

5. SCREENING

The produced 1550nm SLED Module is required to meet all operating conditions specified in Table 3, Electro-Optical Performance Specifications after being subjected to the following screening tests.

Test Item	Test Conditions	Reference
Seal	Fine: Condition A1 Gross: Condition C	MIL-STD-883, Method 1014 Temperature max $85^{\circ}C$
Temperature Cycling	$-40^{\circ}C$ to $+85^{\circ}C$, ramp rate $\geq 5^{\circ}C/min$ 10 cycles	MIL-STD-883, Method 1010

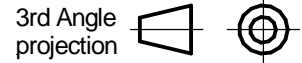

6. PACKAGE DIMENSIONS [mm]

Tolerances : .X ± 0.25 mm
.XX ± 0.05 mm

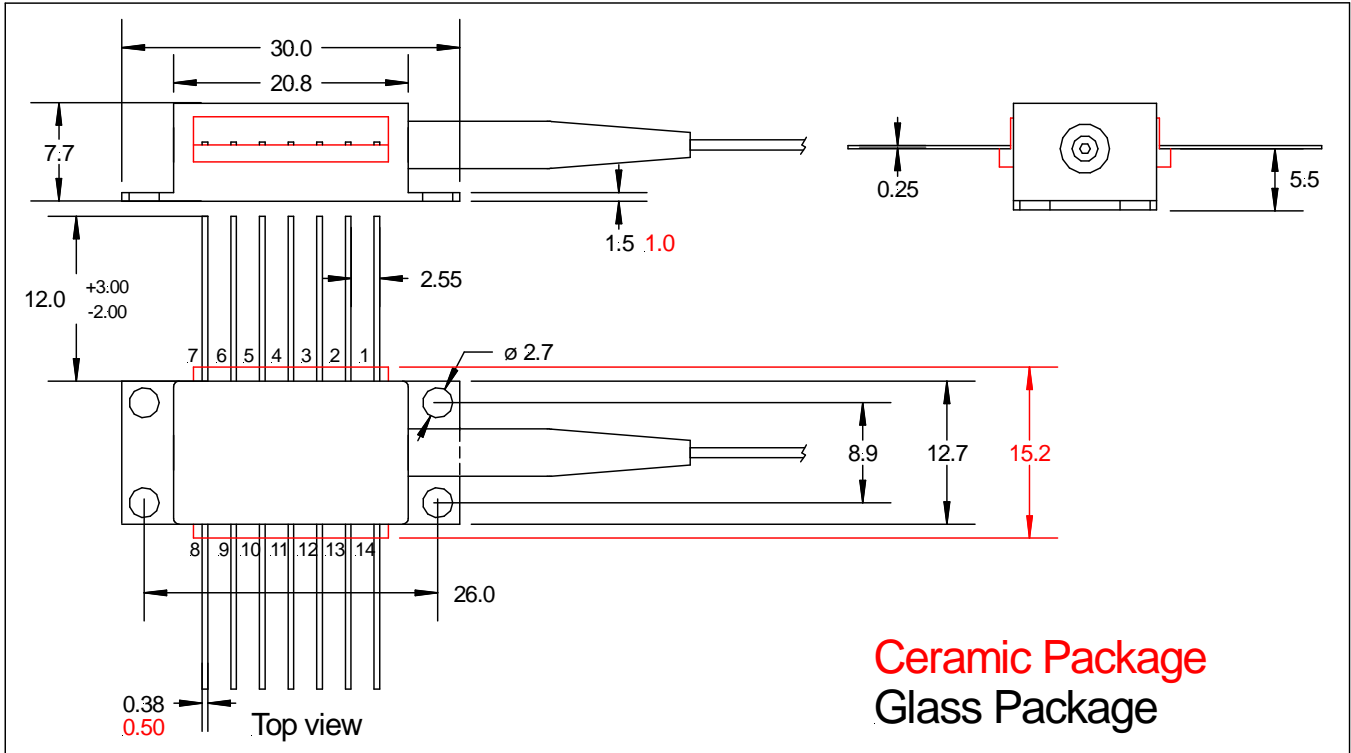

Butterfly Package			
Pin	Function	Pin	Function
1	TEC (+)	8	NC
2	THERMISTOR	9	NC
3	MONITOR DIODE ANODE	10	SLED ANODE (+)
4	MONITOR DIODE CATHODE	11	SLED CATHODE (-)
5	THERMISTOR	12	NC
6	NC	13	CASE GROUND
7	NC	14	TEC (-)

7. FIBRE AND CONNECTOR

Part	Description
SM Fibre	SMF-28, 9/125 µm
Tight buffer secondary coating	900 µm
Fiber pigtail length [min]	1 m
Optical connector	FC/APC Narrow Key (2.0mm)

8. IMPORTANT NOTES

1. Avoid electrostatic discharges, which may destroy the SLED.
2. Never use the bare die without heat sinking.
3. Adequate eye protection against laser radiation should be used while handling and operating the module.
4. EXALOS declines any responsibility if the device is used in applications where human life may be endangered.
5. Back reflections may influence the output power and spectral characteristics of the SLED. The use of optical isolators and/or angled connectors is recommended. Back reflections of less than -30dB are recommended.

9. ORDERING INFORMATION

Please use the following **part number** to order product from EXALOS:

E X S 2 1 0 0 5 4 - 0 1

9.1 TECHNICAL DESCRIPTION

