



900-1000nm OPTICAL ISOLATORS

www.isowave.com
64 Harding Avenue
Dover NJ 07801
Phone 973-328-7000
Fax 973-328-7036
sales@isowave.com

DESCRIPTION

ISOWAVE offers a wide variety of isolators for the 900-1000nm wavelength band with designs centered at 980nm. Features to choose from include 2mm, 4mm and 5mm clear apertures, fixed or tunable polarizers, broad band isolation without tuning and three power level options*. Single and Semi-Double (SD) stage versions provide different isolation level options. A Faraday rotator with no polarizers is also available.

- *Low – Absorptive glass plate
- *Medium – Glan Taylor Polarizer (no escape ports)
- *High – Glan Taylor Polarizer with dual escape ports

FEATURES

- Wide Tuning Range
- Removable Mounting Collar
- High Isolation
- Low Insertion Loss

MODEL NUMBER	Clear Aperture	Tunable	Broad-band	Isolation Minimum / Typical	Ins Loss Typical / Maximum	Transmission Minimum / Typical	Power Handling	Diameter	Length
	mm	Yes/No	Yes/No	dB	dB	%	W/cm2	inch / mm	inch/mm
I-98-2-FR	2	N	N	30 / 35	0.2	95	300	1.0 / 25.4	2.40 / 61
I-98-2L	2	N	N	35 / 38	0.3 / 0.5	89 / 93	50	1.0 / 25.4	2.40 / 61
I-98-2M	2	N	N	35 / 38	0.4 / 0.7	85 / 91	100	1.0 / 25.4	3.54 / 90
I-98-2H	2	N	N	35 / 38	0.4 / 0.7	85 / 91	250	1.0 / 25.4	4.13 / 105
I-9010C-2L	2	N	Y	35 / 38	0.4 / 0.7	85 / 91	50	1.0 / 25.4	2.40 / 61
I-9010C-2M	2	N	Y	35 / 38	0.5 / 0.7	85 / 89	100	1.0 / 25.4	3.54 / 90
I-9010C-2H	2	N	Y	35 / 38	0.5 / 0.7	85 / 89	250	1.0 / 25.4	4.13 / 105
I-98U-2	2	N	N	60 / 63	0.9 / 1.4	72 / 81	50	1.0 / 25.4	3.31 / 84
I-98U-4	4	N	N	60 / 63	0.9 / 1.4	72 / 81	50	1.375 / 34.9	3.9 / 99
I-98-5-FR	5	N	N	30 / 35	0.2	95	300	1.375 / 34.9	3.0 / 76
I-98T-5L	5	Y	N	35 / 38	0.3 / 0.5	89 / 93	50	1.375 / 34.9	4.0 / 102
I-98T-5M	5	Y	N	35 / 38	0.4 / 0.7	85 / 91	100	1.375 / 34.9	4.0 / 102
I-98T-5H	5	Y	N	35 / 38	0.4 / 0.7	85 / 91	250	1.375 / 34.9	5.01 / 127
I-9010C-L	5	Y	Y	35 / 38	0.6 / 0.75	84 / 86	50	1.375 / 34.9	4.0 / 102
I-9010C-M	5	Y	Y	35 / 38	0.6 / 0.75	84 / 86	100	1.375 / 34.9	4.0 / 102
I-9010C-H	5	Y	Y	35 / 38	0.6 / 0.75	84 / 86	250	1.375 / 34.9	5.01 / 127
I-98-SD-L	5	Y	N	55 / 60	1.0 / 1.5	70 / 79	50	1.375 / 34.9	4.69 / 119
I-98-SD-M	5	Y	N	55 / 60	1.0 / 1.5	70 / 79	100	1.375 / 34.9	4.69 / 119
I-98-SD-H	5	Y	N	55 / 60	1.0 / 1.5	70 / 79	250	1.375 / 34.9	4.97 / 127

Part Number Options

FR = Faraday Rotator
 L, M, H = Polarizer Power Level Options: Low, Medium, High
 C = Broadband Isolation: 30dB over +/-50nm no tuning required
 T = Tunable: Input polarizer may be rotated to maximize isolation
 SD = Semi Double: Single center polarizer, two rotator isolator.

Wavelength Options

* All isolators may be ordered centered anywhere between 900-1000nm with 980nm as standard. Isowave will optimize on best effort basis using available lasers, or customer may supply laser for alignment and testing.
 * Unless otherwise specified, all 5mm CA isolators are available as 4mm CA with identical mechanical and optical specifications



900-1000nm OPTICAL ISOLATORS

www.isowave.com
 64 Harding Avenue
 Dover NJ 07801
 Phone 973-328-7000
 Fax 973-328-7036
 sales@isowave.com

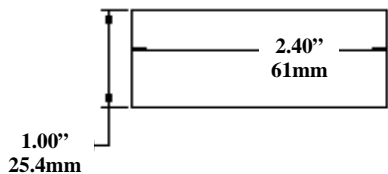

**I-98-2L
I-9010C-2L**

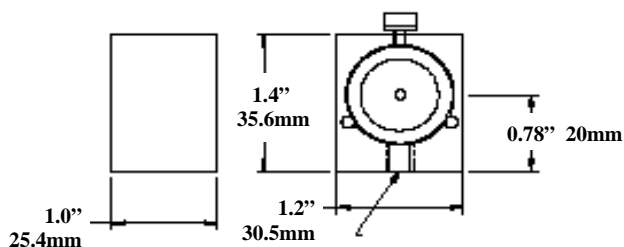

0.74"
19mm

**I-98-2H
I-9010C-2H**

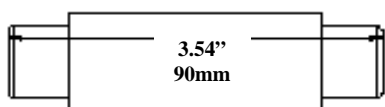

**I-98-2M
I-9010C-2M**

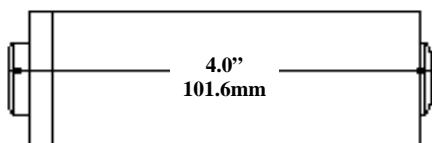
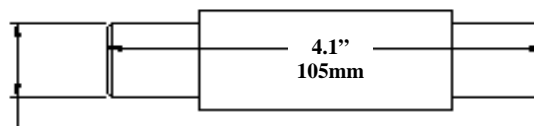

**I-98T-5L or -5M
I-9010C-L or -M**

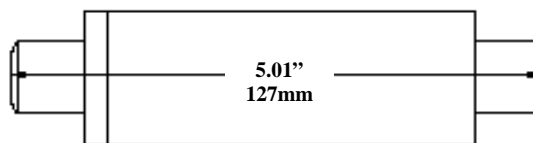

**I-98T-5H
I-9010C-H**

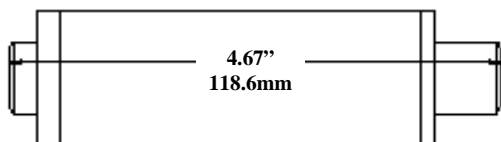

I-98-SD-L or M

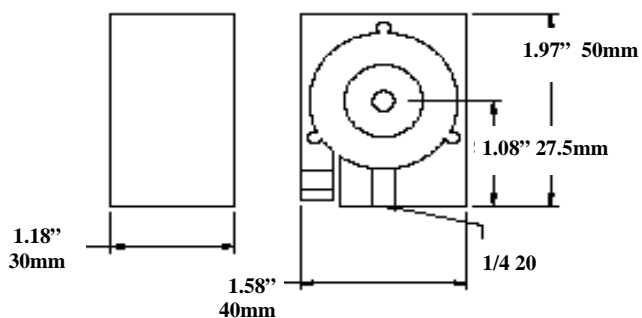



900-1000nm OPTICAL ISOLATORS

www.isowave.com
64 Harding Avenue
Dover NJ 07801
Phone 973-328-7000
Fax 973-328-7036
sales@isowave.com

Theoretical Curve 9010 (Compensated) and 98T (Standard Tunable)

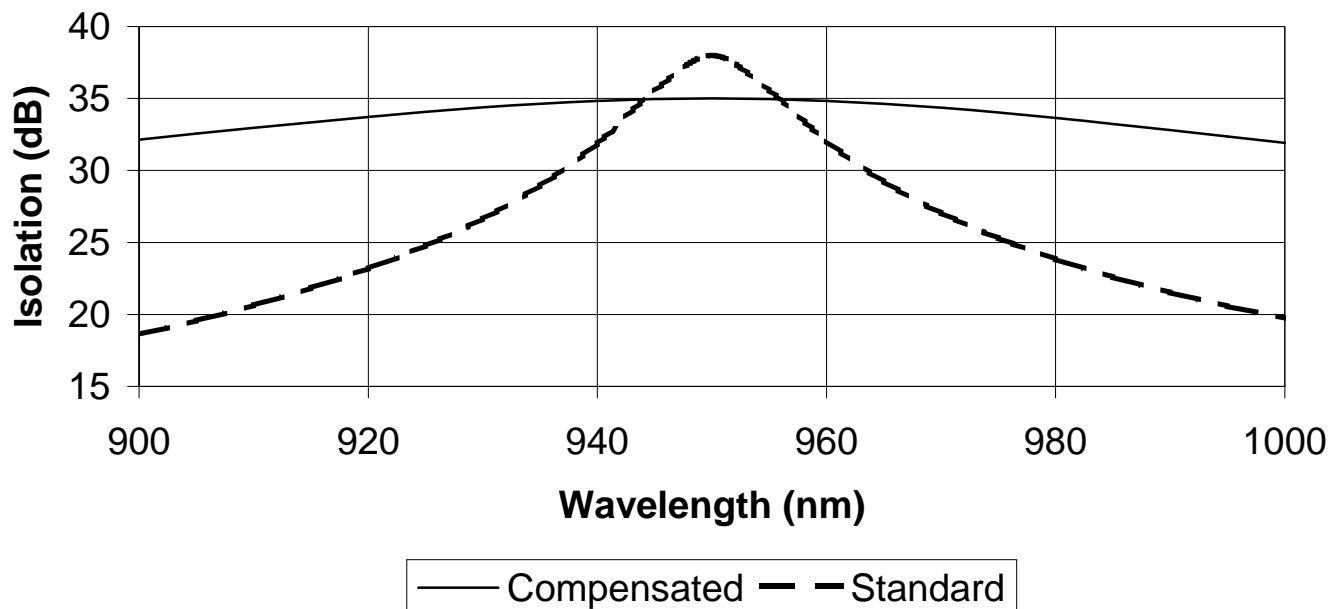

Theoretical Curve I-98-SD

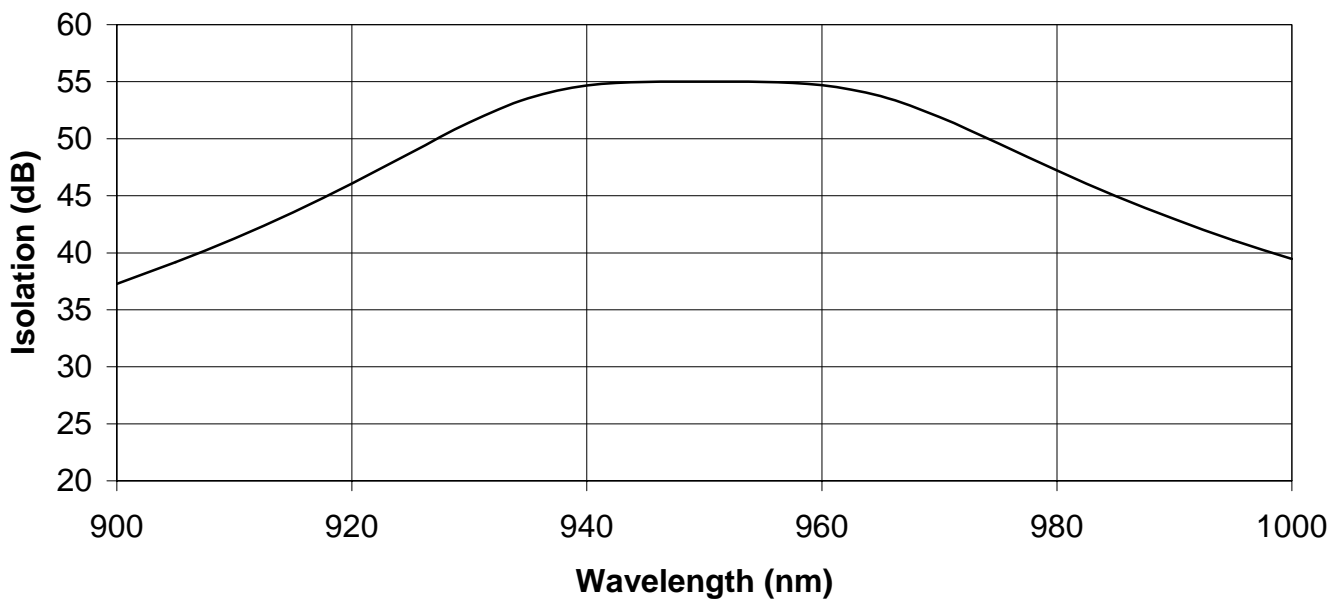

www.isowave.com
64 Harding Avenue
Dover NJ 07801
Phone 973-328-7000
Fax 973-328-7036
sales@isowave.com